



*Digi Connect ME™ &  
Digi Connect Wi-ME™  
Hardware Reference*

---



*Making*  
**DEVICE NETWORKING**  
*easy™*

*Making*  
**DEVICE NETWORKING**  
*easy™*

© Digi International Inc. 2004 -2006. All Rights Reserved.

The Digi logo is a registered trademark of Digi International, Inc.

Connectware and Digi Connect ME and Digi Connect Wi-ME are trademarks of Digi International, Inc.

NetSilicon, NET+Works, NET+OS, and NET+ are trademarks of NetSilicon, Inc.

All other trademarks mentioned in this document are the property of their respective owners.

Information in this document is subject to change without notice and does not represent a commitment on the part of Digi International.

Digi provides this document "as is," without warranty of any kind, either expressed or implied, including, but not limited to, the implied warranties of fitness or merchantability for a particular purpose. Digi may make improvements and/or changes in this manual or in the product(s) and/or the program(s) described in this manual at any time.

This product could include technical inaccuracies or typographical errors. Changes are periodically made to the information herein; these changes may be incorporated in new editions of the publication.



# Contents

---

About This Document .....	vii
Kits Contents .....	vii
Related Documentation .....	viii
Support Information .....	viii
<b>Chapter 1: About the Digi Connect ME &amp; Digi Connect Wi-ME Embedded Modules .</b>	<b>1</b>
Overview .....	1
Types of Modules .....	2
Connectors: Power and Device Interface .....	3
Connectors: Ethernet Interface .....	5
Connectors: Antenna .....	7
Module LEDs .....	7
<b>Chapter 2: About the Development Board .....</b>	<b>9</b>
Overview .....	9
Basic Description .....	10
Port Descriptions .....	12
Connectors and Blocks .....	15
Switches .....	19
Development Board LEDs .....	22
Power Jack .....	24
Test Points .....	25
<b>Chapter 3: Programming Considerations.....</b>	<b>29</b>
Overview .....	29
GPIO.....	30
LEDs.....	32

Reset.....	32
Flash.....	34
<b>Appendix A Module Specifications.....</b>	<b>35</b>
Network Interface .....	35
Serial Interface .....	36
Data Rates (bps).....	36
Flow Control Options.....	36
GPIO .....	36
DC Characteristics .....	37
Environmental.....	38
Mechanical.....	39
Bar Code .....	39
Dimensions.....	40
Recommended PCB Layout.....	45
Antenna Information.....	47
RF Exposure Statement.....	51
Safety Statements.....	51
<b>Appendix B Certifications.....</b>	<b>53</b>
FCC Part 15 Class B .....	53
Industry Canada .....	54
Declaration of Conformity.....	55
International EMC Standards.....	56
<b>Appendix C Sample Application: TTL Signals to EIA-232 .....</b>	<b>57</b>
<b>Appendix D Change Log .....</b>	<b>59</b>
Revision G.....	59
Revision F .....	59
Revision E.....	60



# About This Document

---

## Scope of the Reference Manual

---

The purpose of this document is to enable developers to integrate the Digi Connect ME or Digi Connect Wi-ME embedded modules with other devices, enabling these devices to make use of the module's rich networking features.

**Note** Unless mentioned specifically by name, the products will be referred to as the embedded modules or modules. Individual naming is used to differentiate product specific features.

## Kits Contents

---

This manual is intended for customers who use embedded modules Integration Kits or Development Kits, which are described below.

### About the Integration Kit

The integration kit is the ideal platform for product evaluation, rapid prototyping, and integration of the embedded modules. Targeted specifically at customers who want to take advantage of the embedded modules with Digi plug-and-play firmware functionality, it enables integration of the modules without any extensive embedded software development with all the additional flexibility and benefits of web user interface customization and application specific java applets.

### About the Development Kit

The Digi Connect ME or Digi Connect Wi-ME Development Kit are easy-to-use and royalty-free development platforms that significantly reduces traditional design risk and accelerates the overall software development process. The kits deliver the integrated

building blocks to quickly and cost effectively create your own custom firmware for an embedded module based high-performance networking solution that fits the specific requirements of your application.

## Related Documentation

---

See the *NS7520 Hardware Reference* for information on the NS7520 chip.

## Support Information

---

To get help with a question or technical problem or make comments and recommendations about Digi products and documentation, use the following contact information.

### *General*

Digi International  
11001 Bren Road East  
Minnetonka, MN 55343  
U.S.A.

### *Customer Service and Support*

United States: 1 877-912-3444  
Other Locations: 1 952-912-3444  
[www.digi.com/support/](http://www.digi.com/support/)  
[www.digi.com](http://www.digi.com)



# *About the Digi Connect ME & Digi Connect Wi-ME Embedded Modules*

---

## C H A P T E R 1

### Overview

---

The embedded modules provide fully transparent device connectivity over industry-standard Ethernet connections and allows both equipment manufacturers and systems integrators to network-enable products at a fraction of the time and cost required to develop a custom solution. It is a highly flexible and compact single component solution with a serial port, GPIO ports, and a robust on-board TCP/IP stack and 10/100 BASE-T Ethernet support or wireless interface..

From medical systems to building control and industrial automation, in virtually any application where embedded device connectivity over Ethernet or wireless connectivity is needed, embedded modules are the ideal choice, delivering high-performance functionality.

**Note** Unless mentioned specifically by name, the products will be referred to as the embedded modules or modules. Individual naming is used to differentiate product specific features.

This chapter provides information about the modules hardware and contains the following topics:

- "Types of Modules" on page 2
- "Connectors: Antenna" on page 7
- "Connectors: Ethernet Interface" on page 5
- "Module LEDs" on page 7

## Types of Modules

The type of module that you will use for hardware integration depends on the kit you are using. If you are using an integration kit, you will be using a module without a JTAG interface. If you are using a development kit, you will be using a module with a JTAG interface.

**Note** JTAG is a commonly used term that is also referred to as IEEE 1149.1, an industry standard test protocol. JTAG is an abbreviation for the European Joint Test Action Group, which invented the first versions of the IEEE 1149.1 interface. The JTAG interface, along with the other development tools, enables you to download, run and debug programs on the module.

The following figures show the two types of modules.

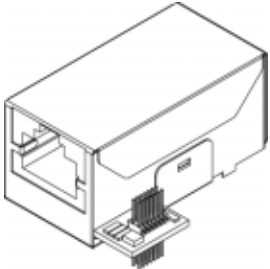
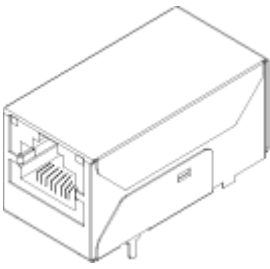
Digi Connect ME Modules		
Model	Description	Figure
DC-ME-01T-JT	<ul style="list-style-type: none"> <li>■ Used for development purposes only</li> <li>■ JTAG interface</li> </ul>	
DC-ME-01T-S DC-ME-01T-C	<ul style="list-style-type: none"> <li>■ No JTAG interface</li> <li>■ Ordered independently of either kit for use in your implementation.</li> </ul>	

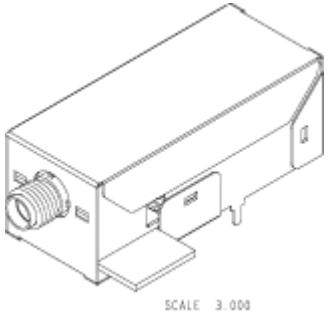
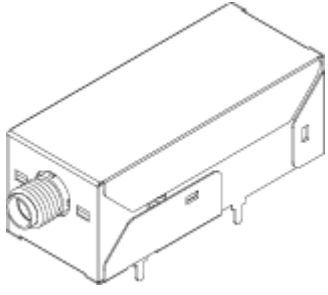
Digi Connect Wi-ME Modules		
Model	Description	Figure
DC-WME-01T-JT	<ul style="list-style-type: none"> <li>■ Used for development purposes only</li> <li>■ JTAG interface</li> </ul>	
DC-WME-01T-S DC-WME-01T-C	<ul style="list-style-type: none"> <li>■ No JTAG interface</li> <li>■ Ordered independently of either the development or integration kit for use in your implementation.</li> </ul>	

**Note** -**S**: No JTAG for use with Digi Firmware  
 -**C**: No JTAG for use with Custom Firmware  
 -**JT**: With JTAG for use with custom firmware development

## Connectors: Power and Device Interface

---

The module has a 20-pin male connector that supports a serial interface with data rates up to 230,400 bps and full-modem control, and GPIO ports. See the following figure for pin orientation and the table for pin assignments.

## Difference in pin assignments/availability

Pin assignments/availability for pins 1 and 2 depend on which module you are using. Pins 1 and 2 are available for Digi Connect ME; these pins are removed for Digi Connect Wi-ME. The pin assignment table shows the appropriate values.

## Power and Device Interface Connector Digi Connect Wi-ME

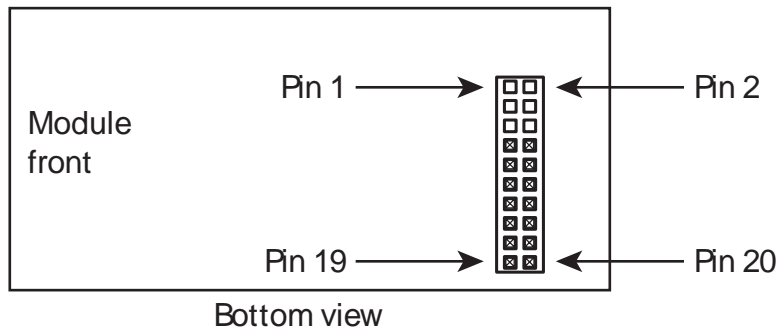

61000000

Power and Device Interface Connector Pin Assignments Digi Connect Wi-ME		
Pin	Signal	Description
1	ME: VETH+ Wi-ME: —	ME: Power Pass-Thru+ Wi-ME: Position Removed
2	ME: VETH- Wi-ME: —	ME: Power Pass-Thru- Wi-ME: Position removed
3-6	—	Position removed
7	RXD	Receive Data (Input)
8	TXD	Transmit Data (Output)
9	RTS / GPIO 4	Request to Send (Output) / GPIO
10	DTR / GPIO 5	Data Terminal Ready (Output) / GPIO

<b>Power and Device Interface Connector Pin Assignments Digi Connect Wi-ME</b>		
<b>Pin</b>	<b>Signal</b>	<b>Description</b>
11	CTS / GPIO 2	Clear to Send (Input) / GPIO
12	DSR / GPIO 3	Data Set Ready (Input) / GPIO
13	DCD / GPIO 1	Data Carrier Detect (Input) / GPIO
14	RESET	Reset
15	+3.3V	Power
16	GND	Ground
17-19	—	Reserved. Do not connect.
20	/INIT	Software Reset

**Note** The development board provides a reference design of a POE (Power Over Ethernet) power supply. A schematic for this reference design is installed by the setup program on the CD.

## Connectors: Ethernet Interface

The Ethernet connector is an 8-wire RJ-45 jack that meets the ISO 8877 requirements for 10/100BASE-T. See the following figure and table for pin orientation and pin assignments.

**Note** Pin orientation and assignments are the same for modules with or without a JTAG connector.

## Ethernet Interface Pin Orientation

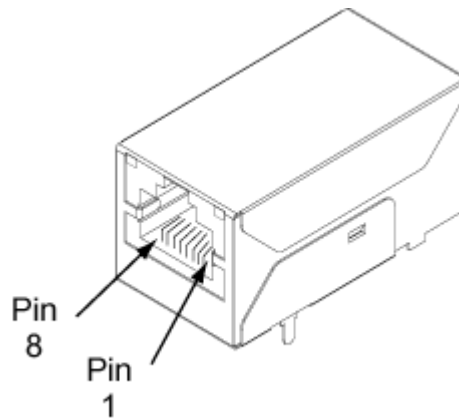

Ethernet Interface Pin Assignments							
Pin 1	Pin 2	Pin 3	Pin 4	Pin 5	Pin 6	Pin 7	Pin 8
TXD+	TXD-	RXD+	EPWR+	EPWR+	RXD-	EPWR-	EPWR-
Transmit Data +	Transmit Data -	Receive Data +	Power from Switch +	Power from Switch +	Receive Data -	Power from Switch -	Power from Switch -

## Hard Reset

The embedded modules support a hardware reset on pin 10 of the 12-pin header. The unit will be forced into a hard reset if this pin is pulled low. When used with the development board, this pin is wired to reset button SW5, which means it acts as a hard reset button.

## Connectors: Antenna

The Digi Connect Wi-ME is available with 1 RP-SMA connector. The antenna is connected to the module with a reverse polarity SMA connector (sub-miniature size A). The antenna only fits on the module one way to ensure a proper connection. Another option for both signal reception and design flexibility is to use an antenna extension cord (Digi part number DC-ANT-E-24DP) to separate the antenna from the module. This allows the module to fit inside your product but the antenna to be placed outside the device.



**Caution:** This Part 15 radio device operates on a non-interference basis with other devices operating at this frequency when using the antennae listed in the Antenna Specification table. Any changes or modification to the product not expressly approved by Digi International could void the user's authority to operate the device.

Antenna Specifications			
<b>Type</b>	Desktop	Dipole	30 cm Antenna Extension Cord
<b>Part number</b>	DC-ANT-24DT	DC-ANT-24DP	DC-ANT-E-24DP
<b>Gain</b>	1.8 dBi	2 dBi	-.5dB

## Module LEDs

The module has two LEDs that are located near the upper corners of the Ethernet port (see the following figure). The following table describes the LEDs.

**Note** The LEDs are the same for a module with or without a JTAG connector.

## LED Locations

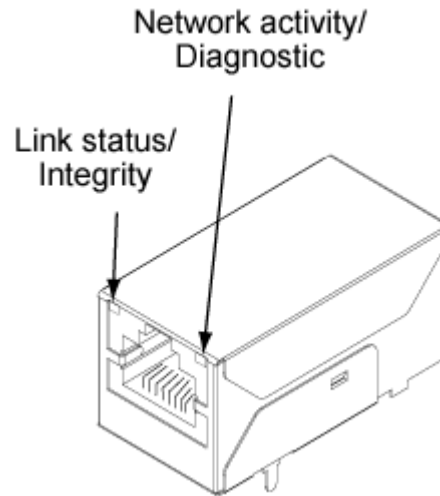

LED Behaviors				
LED	Pin Header EM	Integration Kit Digi Connect ME	Integration Kit Digi Connect Wi-ME	Development Kit
Top left (yellow)	5 (+) 7 (-)	Network link status: Off - no link has been detected. On - a link has been detected.	Network link status: On - unit is associated with an access point Blinking slowly - unit is in ad hoc mode Blinking quickly - unit is scanning for a network	Same as Integration Kit (Network link status)
Top right (green)	1 (+) 3 (-)	Serial port activity/Network activity: Off - the serial channel is idle. Blinking - serial data is transmitted or received.		This LED is software programmable



# About the Development Board

---

## C H A P T E R 2

### Overview

---

The development board is a hardware platform from which you can determine how to integrate the embedded modules into your design. The board consists of the following main features:

- Socket for connecting the embedded modules
- JTAG connection (for use with the development kit only)
- GPIO switches
- Serial and GPIO ports
- Power input

This chapter provides information on development board components and contains the topics listed below. For more detailed information on the development board, see the schematic and mechanical drawings on the CD that accompanies your integration kit or development kit. (If you have installed the integration kit or development kit, you can access the schematic from the Start menu.)

- "Basic Description" on page 10
- "Placement of Module" on page 12
- "Connectors and Blocks" on page 15
- "Switches" on page 19
- "Development Board LEDs" on page 22
- "Power Jack" on page 24
- "Test Points" on page 25

## Basic Description

The development board contains connectors, switches, and LEDs for use while integrating the embedded module into your design. See the following figure for the location of the connectors, switches, and LEDs. Additionally, the board provides test points (not shown on the figure). For more information about test points, see "Test Points" on page 25.

### Board Layout

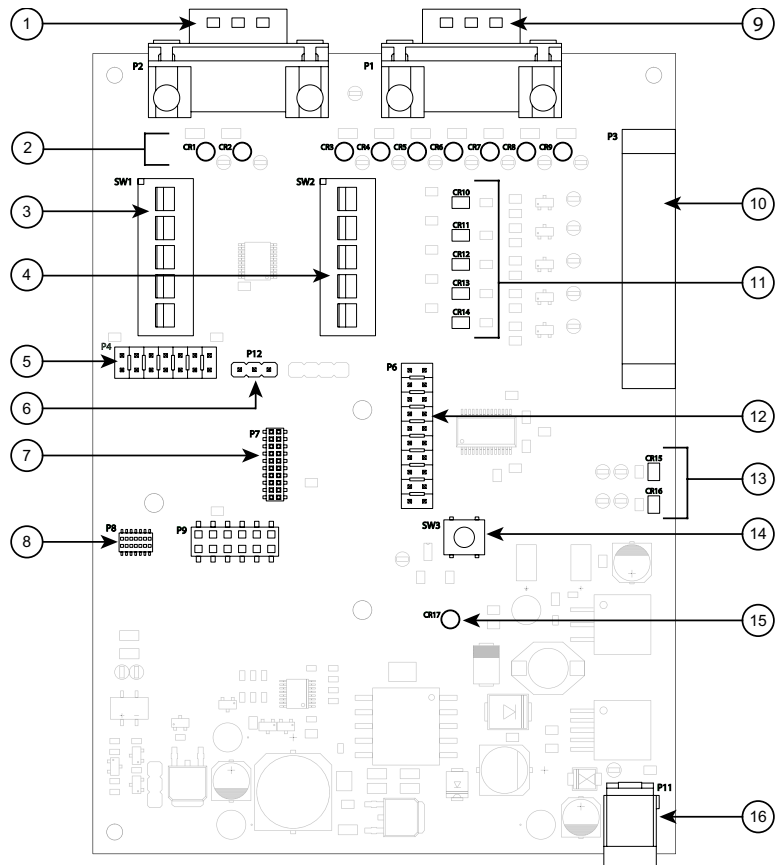

00000005

Connectors, Switches and LEDs Board Description Markers 1-8							
1	2	3	4	5	6	7	8
Secondary Serial Port, P2	LEDs, CR1 -CR9	GPIO Switch Bank, SW1	GPIO Switch Bank, SW2	JTAG Header, P4	Jumper Block, P12 (Reserved)	Embedded Module Connector, P7	JTAG Connector, P8

Connectors, Switches and LEDs Board Description (continued) Markers 9-16							
9	10	11	12	13	14	15	16
Primary Serial Port, P1	GPIO Port, P3	LEDs, CR10 - CR14	Digital Signal Monitor Jack, P6	LEDs, CR15 and CR16	Reset Switch, SW3	LED, CR17	Power Jack, P11

**Caution** When handling the development board, wear a grounding wrist strap to avoid ESD damage to the board.

For more detailed information on connectors, switches and LEDs, see the following:

- "Port Descriptions" on page 12
- "Connectors and Blocks" on page 15
- "Switches" on page 19
- "Development Board LEDs" on page 22
- "Power Jack" on page 24

The development board accepts either of the following modules:

- Module without JTAG connector—for use with an integration kit
- Module with JTAG connector—for use with a development kit

See the following figures for placement of either module onto the development board.

## Placement of Module

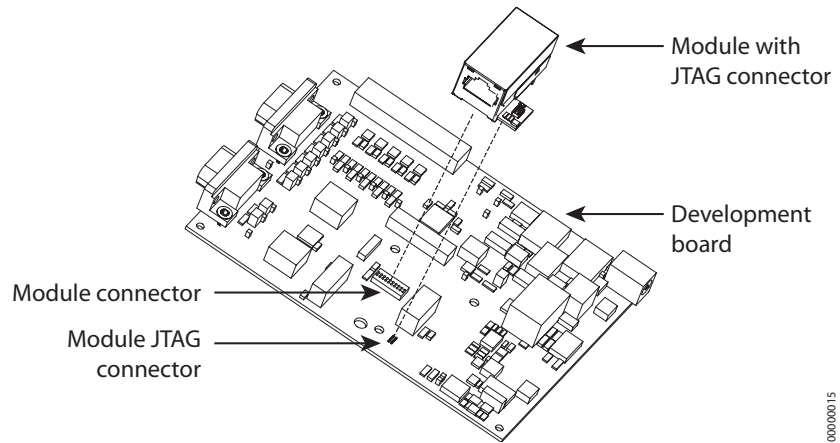

**Caution** If you handle the module, wear a grounding wrist strap to avoid ESD damage.

## Port Descriptions

---

The development board provides the following ports:

- Primary Serial Port, P1
- Secondary Serial Port, P2
- GPIO Port, P3

See the figure titled "Board Layout" on page 10 for the location of the ports. The following sections describe the ports.

### Primary Serial Port, P1

The Primary Serial Port is a DB-9 male connector that is labeled as P1 on the development board. The port is used with the integration kit and the development kit. See the following figure for pin orientation; see the following table for pin assignments.

## Primary Serial Port Pin Orientation

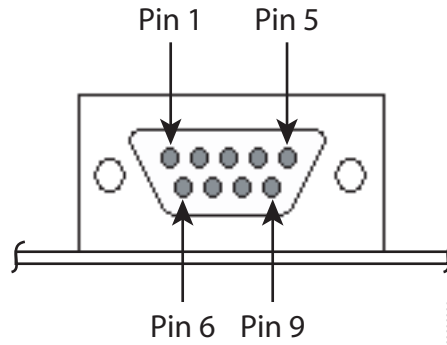

Primary Serial Port Pin Assignments								
Pin 1	Pin 2	Pin 3	Pin 4	Pin 5	Pin 6	Pin 7	Pin 8	Pin 9
DCD	RXD	TXD	DTR	GND	DSR	RTS	CTS	—
Data Carrier Detect	Receive Data	Transmit Data	Data Terminal Ready	Signal/Chassis Ground	Data Set Ready	Request To Send	Clear To Send	—

## Secondary Serial Port, P2

The Secondary Serial Port is a DB-9 male connector that is labeled as P2 on the development board. The port is used only with the Digi Connect ME modules with JTAG interfaces (in the development kit) for debugging purposes. See the following figure for pin orientation; see the following table for pin assignments.

## Secondary Serial Port Pin Orientation

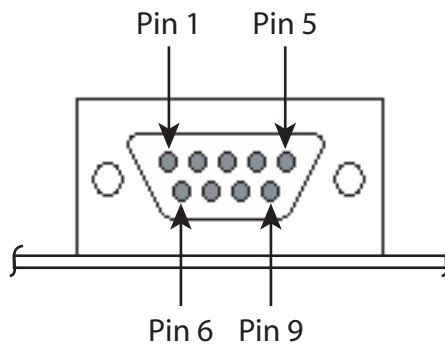

Secondary Serial Port Pin Assignments								
Pin 1	Pin 2	Pin 3	Pin 4	Pin 5	Pin 6	Pin 7	Pin 8	Pin 9
—	RXD	TXD	—	GND	—	—	—	—
—	Receive Data	Transmit Data	—	Signal/ Chassis Ground	—	—	—	—

## GPIO Port, P3

The GPIO port is a 10-pin male right-angle connector that is labeled as P3 on the development board. The port is used with the integration kit and the development kit. See the following figure for pin orientation; see the following tables for pin assignments. For input and output threshold specifications, see "DC Characteristics" on page 37.

**Note** The development board is shipped with a 10-pin screw-flange plug attached to the GPIO port.

## GPIO Port Pin Orientation

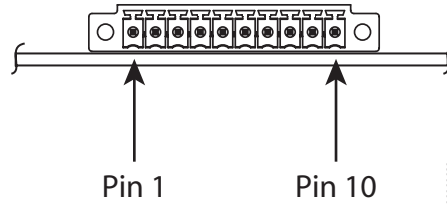

**GPIO Port Pin Assignments**

	Pin 1	Pin 2	Pin 3	Pin 4	Pin 5	Pin 6	Pin 7	Pin 8	Pin 9	Pin 10
Signal	GND	GPIO-5	GND	GPIO-4	GND	GPIO-3	GND	GPIO-2	GND	GPIO-1

## Connectors and Blocks

---

The development board provides the following connectors and blocks:

- Embedded Module Connector, P7
- Module JTAG Interface Connector, P8
- JTAG Debugger Connector, P4
- Jumper Block, P12
- Logic Analyzer Header, P6

See the figure titled "Board Layout" on page 10 for the location of the connectors and blocks. The following sections describe the connectors and blocks.

### Embedded Module Connector, P7

The Digi Connect ME embedded module Connector is a 20-pin female vertical header that is labeled P7 on the development board. The connector is used with the integration kit and

the development kit. See the following figure for pin orientation; see the following table for pin assignments.

Note: The figure shows the connector using the same orientation as shown in the figure titled "Board Layout" on page 10.

### Embedded Module Connector Pin Orientation

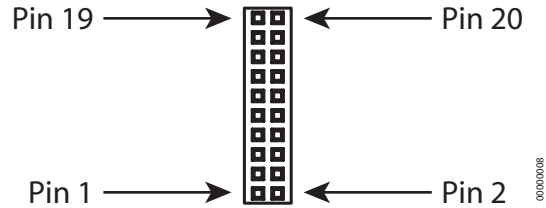

Module Connector Pin Assignments		
Pin	Signal	Description
1	ME: VETH+ Wi-ME: —	ME: Power Pass-Thru + Wi-ME: Position removed
2	ME: VETH- Wi-ME: —	ME: Power Pass-Thru - Wi-ME: Position removed
3-6	—	Position Removed
7	RXD	Receive Data (Input)
8	TXD	Transmit Data (Output)
9	RTS / GPIO-4	Request to Send (Output) / GPIO
10	DTR / GPIO-5	Data Terminal Ready (Output) / GPIO
11	CTS / GPIO-2	Clear to Send (Input) / GPIO
12	DSR / GPIO-3	Data Set Ready (Input) / GPIO



Module Connector Pin Assignments		
Pin	Signal	Description
13	DCD / GPIO-1	Data Carrier Detect (Input) / GPIO
14	RESET	Reset
15	+3.3V	Power
16	GND	Ground
17-19	—	Reserved. Do not connect.
20	/INIT	Software Reset

### Module JTAG Interface Connector, P8

The Module JTAG Interface Connector is a 14-pin female vertical header that is labeled P8 on the development board. The connector mates with the JTAG connector on the Digi Connect ME embedded module. The Module JTAG Connector pins are tied to the JTAG debugger Connector (see “JTAG Debugger Connector, P4”).

**Note** Because there is no direct connection to the Module JTAG Interface Connector, pin orientation and pin assignments are not described for the connector.

### JTAG Debugger Connector, P4

The JTAG debugger connector is a 14-pin male vertical header that is labeled P4 on the development board. The connector mates with a JTAG debugger plug (for example, a Macraigor Raven). The connector is used with the development kit only. See the following figure for pin orientation. See the following table for pin assignments.

**Note** The figure shows the connector using the same orientation as shown in the figure titled "Board Layout" on page 10.

## JTAG Debugger Connector Pin Orientation

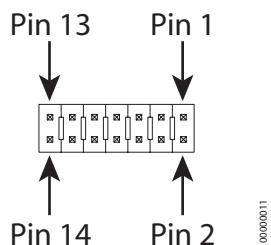

### JTAG Debugger Connector Pin Assignments

Pin 1	Pin 2	Pin 3	Pin 4	Pin 5	Pin 6	Pin 7	Pin 8	Pin 9	Pin 10	Pin 11	Pin 12	Pin 13	Pin 14
VCC+	GND	/TRST	GND	TDI	GND	TMS	GND	TCKRXD	GND	TDO	ICETRST	VCC+	GND

### Jumper Block, P12

This jumper block is reserved for future use.

### Logic Analyzer Header, P6

The Logic Analyzer Header is a 20-pin male vertical header that is labeled P6 on the development board. The header is for connecting a digital signal analyzer (for example, a logic analyzer) to the development board. The header is used with the development kit only. See the following figure for pin orientation; see the following table for pin assignments.

**Note** The figure shows the connector using the same orientation as shown in the figure titled "Board Layout" on page 10.

### Logic Analyzer Header Pin Orientation

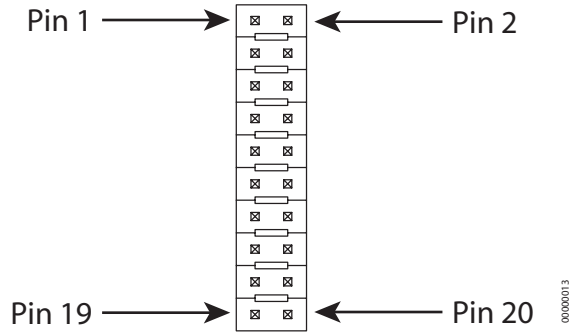

**Logic Analyzer Header Pin Assignments**

Pin 1-8	Pin 9	Pin 10	Pin 11	Pin 12	Pin 13	Pin 14	Pin 15	Pin 16	Pin 17	Pin 18	Pin 19	Pin 20
Not Connected	/RST	Not Connected	GPIO-5	TXD2	GPIO-4	RXD2	GPIO-3	TXD	GPIO-2	RXD	GPIO-1	GND

## Switches

The development board provides the following switches:

- GPIO Switch Bank 1, SW1
- GPIO Switch Bank 2, SW2
- Reset, SW3



See the figure titled "Board Layout" on page 10 for the location of the switches. The following sections describe the switches.

### GPIO Switch Bank 1, SW1

GPIO Switch Bank 1, labeled SW1, is a set of five slide switches that allows the Digi Connect ME embedded module to use either serial signals or GPIO signals to communicate with a device. The switch is used with the Digi Connect ME embedded module Integration

Kit and the Digi Connect ME embedded module Development Kit. In addition, the switch is used in conjunction with GPIO Switch Bank 2, SW2. See the following table for switch definitions of GPIO Switch Bank 1.

### GPIO Switch Bank 1 Settings

Switch Number	Left Position 	Right Position 
1	DCD	GPIO-1
2	CTS	GPIO-2
3	DSR	GPIO-3
4	RTS	GPIO-4
5	DTR	GPIO-5

## GPIO Switch Bank 2, SW2

GPIO Switch Bank 2, labeled SW2, is a set of five slide switches that set GPIO inputs to logic levels of high (switch to left) or low (switch to right).

If the GPIO port is configured as an output, then the switch should always be to the left. If there is an external device connected to P3, the switch should always be set to the left.

Each GPIO port can be used independently.

### *Notes*

- 1 These switches do not determine whether the GPIO is an input or output. That is determined by the module software.
- 2 If GPIO is set to an output by software, switch SW2 must be set to the left (high).
- 3 These switches are used with the integration kit and the development kit and in conjunction with GPIO Switch Bank 1, SW1.

## Reset, SW3

The Reset switch is a push button switch labeled SW3 on the development board. Pressing the switch holds the Digi Connect ME embedded module in reset. When the push button is released, the module reboots.

## Development Board LEDs

The development board contains 17 LEDs that are labeled CR1 through CR17. The following table lists and describes the LEDs.

<b>Development Board LED Descriptions</b>			
<b>Board Label</b>	<b>Description</b>	<b>Color or State</b>	<b>Indication</b>
CR1	TXD, Secondary Serial Port	Flickering	Serial activity
		Green	Inactive
CR2	RXD, Secondary Serial Port	Flickering	Serial activity
		Green	Inactive
CR3	CTS, Primary Serial Port	Yellow	Active
		Green	Inactive
		Off	Not connected or signal not being driven
CR4	DTR, Primary Serial Port	Yellow	Active
		Green	Inactive
		Off	Not connected or signal not being driven
CR5	TXD, Primary Serial Port	Flickering	Serial activity
		Green	Inactive
CR6	RXD, Primary Serial Port	Flickering	Serial activity
		Green	Inactive

<b>Development Board LED Descriptions</b>			
<b>Board Label</b>	<b>Description</b>	<b>Color or State</b>	<b>Indication</b>
CR7	RTS, Primary Serial Port	Yellow	Active
		Green	Inactive
		Off	Not connected or signal not being driven
CR8	DCD, Primary Serial Port	Yellow	Active
		Green	Inactive
		Off	Not connected or signal not being driven
CR9	DSR, Primary Serial Port	Yellow	Active
		Green	Inactive
		Off	Not connected or signal not being driven
CR10	GPIO-1 Input/Output	On	Logic high
		Off	Logic low
CR11	GPIO-2 Input/Output	On	Logic high
		Off	Logic low
CR12	GPIO-3 Input/Output	On	Logic high
		Off	Logic low

Development Board LED Descriptions			
Board Label	Description	Color or State	Indication
CR13	GPIO-4 Input/Output	On	Logic high
		Off	Logic low
CR14	GPIO-5 Input/Output	On	Logic high
		Off	Logic low
CR15	3.3V Indicator	On	Power on
		Off	Power off
CR16	5V Indicator	On	Power on
		Off	Power off
CR17	EPWR, Powered Ethernet Enabled	On	Ethernet power present from external powered Ethernet connector (Ethernet hub or switch)
		Off	No powered Ethernet voltage

## Power Jack

---

The Power Jack is a barrel connector that accepts 9 to 30 VDC +/- 5%. The jack is labeled as P11 on the development board. The following table shows the polarity of the power jack.



Power Jack Polarity	
Contact	Polarity
Center	+9 to +30 VDC
Outer	Ground

The following figure schematically represents the polarity of the power jack.

### Power Jack Polarity, Schematic

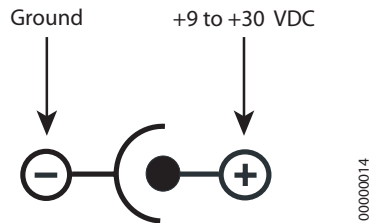

## Test Points

---

The development board provides 24 test points that can be identified by board label or test point number. The board labels are adjacent to each test point on the board. The test point numbers are in the development board schematic drawings. The following table lists the test point number, board label, and a brief description of each test point.

Test Point Descriptions		
Test Point	Board Label	Description
TP1	RI	RI (test point supported only)

<b>Test Point Descriptions</b>		
<b>Test Point</b>	<b>Board Label</b>	<b>Description</b>
TP2	TX	TXD-2, Transmit, Secondary Serial Port
TP3	RX	RXD-2, Receive, Secondary Serial Port
TP4	CTS	CTS, Primary Serial Port
TP5	DTR	DTR, Primary Serial Port
TP6	TX	TXD, Primary Serial Port
TP7	RX	RXD, Primary Serial Port
TP8	RTS	RTS, Primary Serial Port
TP9	DCD	DCD, Primary Serial Port
TP10	DSR	DSR, Primary Serial Port
TP11	GPIO1	GPIO-1
TP12	GPIO2	GPIO-2
TP13	GPIO3	GPIO-3
TP14	GPIO4	GPIO-4
TP15	GPIO5	GPIO-5
TP16	GND	Ground
TP17	3.3V	3.3V Supply

<b>Test Point Descriptions</b>		
<b>Test Point</b>	<b>Board Label</b>	<b>Description</b>
TP18	GND	Ground
TP19	5V	5.0V Supply
TP20	RESET	Reset (active low)
TP21	E+	Ethernet Power +
TP22	E-	Ethernet Power -
TP23	V-IN	9-30 VDC Input
TP24	GND	Ground



# *Programming Considerations*

---

## C H A P T E R 3

### **Overview**

---

This chapter provides information programmers may require to make use of some Digi Connect ME hardware resources. It provides information on the following topics:

- "GPIO" on page 30
- "LEDs" on page 32
- "Reset" on page 32
- "Flash" on page 34
- "Memory" on page 34

## GPIO

---

### General Information

The NS7520 processor supports 16 general purpose I/O (GPIO) lines, some of which are reserved for specific functions and some of which can be customized. These GPIO lines fall into three categories:

- Those labeled “Reserved” in the following table are reserved for a specific use and must not be reprogrammed, or the unit might not operate correctly. Often, these lines are not connected to external interfaces.
- Those labeled “Allocated” in the following table are exposed to an external interface and allocated to a specific use by the software, but can be customized safely with code modifications.
- Those labeled “Available” are exposed to an external interface, not controlled directly by the software, and can be customized.

Two registers govern the 16 GPIO lines. These registers are named PORTA and PORTC. Each GPIO pin has four bits which completely describe its behavior, and each register is responsible for eight GPIO pins. The four bits that describe the GPIO behavior are its mode (CMODE), its direction (CDIR), its special function (CSF--only applicable to PORTC), and the data value. The first three bits describe the functionality of the GPIO pin. The "data" bit provides the current value of the pin when read and allows one to control the value of an output pin when written.

In order to configure any GPIO pin as a GPIO input, the corresponding bit positions in the appropriate register must be configured as: CMODE = 0 CDIR = 0 CSF = 0

In order to configure any GPIO pin as a GPIO output, the corresponding bit positions in the appropriate register must be configured as: CMODE = 0 CDIR = 1 CSF = 0

Since each register controls 8 GPIO lines, it is safest to read the full 32 bit register, modify the bits corresponding to the GPIO line of interest, and then write the full 32 bits back. In this way, the behavior of the other GPIO lines will be preserved. For more information regarding the format and programming of the GPIO registers, see the *NS7520 Hardware Reference*.

<b>Digi Connect ME GPIO pin use</b>				
<b>Name</b>	<b>Register Bit</b>	<b>Category</b>	<b>External Interface</b>	<b>Description</b>
Serial transmit	PORTA7	Allocated	Pin 8 on the 20 pin header	Used for serial transmit. It could be reassigned as GPIO input or output and used for a general purposes.
DTR/GPIO5	PORTA6	Allocated	Pin 10 on the 20 pin header	Used for the serial DTR signal. It can be reassigned as either GPIO input or output and used for a general purpose. If used in conjunction with the development board, this pin maps to GPIO5.
RTS/GPIO4	PORTA5	Allocated	Pin 9 on the 20 pin header.	Used for the serial RTS signal. It could be reassigned as either GPIO input or output and used for a general purpose. If used in conjunction with the development board, this pin maps to GPIO4.
NA	PORTA4	Reserved	NA	NA
Serial receive	PORTA3	Allocated	Pin 7 on 20 pin header,	Used for serial receive. It could be reassigned as either GPIO input or output and used for a general purpose.
DSR/GPIO3	PORTA2	Allocated	Pin 12 on 20 pin header	Used for the serial DSR signal. It could be reassigned as either GPIO input or output and used for a general purpose. If used in conjunction with the development board, this pin maps to GPIO3.
CTS/GPIO2	PORTA1	Allocated	Pin 11 on 20 pin header	Used for the serial CTS signal, but could be reassigned as either GPIO input or output and used for a general purpose. If used in conjunction with the development board, this pin maps to GPIO2.
DCD/ GPIO1	PORTA0	Allocated	Pin 13 on 20 pin header.	Used for the serial DCD signal, but could be reassigned as either GPIO input or output and used for a general purpose. If used in conjunction with the development board, this pin maps to GPIO1.
NA	PORTC7	Reserved	NA	NA
Green LED	PORTC6	Allocated	Connected to the green LED	Used as the Ethernet activity LED, but could be reassigned as a general purpose LED. It must remain a GPIO output for the LED to operate correctly. The LED is lit when the signal is a logic low.
/INIT	PORTC5	Available	Pin 20 on 20 pin header	Can be configured for either GPIO input or GPIO output
NA	PORTC4 - PORTC0	Reserved	NA	NA

## LEDs

---

### General Information

The embedded modules have two types of LEDs:

- An LED connected directly to GPIO pins on the processor and controlled directly in software
- An LED connected to other hardware components (normally the Ethernet hardware) and not directly programmable by the operating system

The development kit, by default, correctly configures the GPIO connected to the LED (PORTC6) as an output and then uses this LED to represent Ethernet activity. For more information regarding the control of LEDs, see the *Net+Works with GNU Tools BSP Porting Guide*.

### About Digi Connect ME LEDs

LED	Description
Yellow	This is wired directly to Ethernet hardware and provides an indication of link.
Green	This software programmable LED is wired to processor GPIO register bit PORTC6 and is wired to be lit when low. The default behavior is to blink on Ethernet activity.

## Reset

---

### Hard Reset

The embedded module supports a hardware reset via pin 14 of the 20-pin header. The unit is forced into a hard reset when pulling the pin to ground, or less than 2.88v, for one microsecond. When plugged into a development board, this pin is wired to the push button at SW3. As a result, this switch acts as a hard reset button.



Reset Characteristics	
Characteristic	Specification
Delay	250 milliseconds (typical)
Threshold	2.88 V
Minimum Hold Time	1 microsecond pulse

## Soft Reset

Net+OS provides an internal facility to enact a soft reset, but it is the responsibility of a specific implementation to choose a reasonable trigger to invoke it. One choice is to use a GPIO pin as a signal to trigger a soft reset. The Digi Connect ME has one GPIO pin named "/INIT" (PORTC5) that is not normally assigned to any other task. It is an ideal candidate for a soft reset. The signal is exposed via pin 20 on the 20-pin header, so it can be controlled by an embedded host. When plugged into the development board, the /INIT signal is pulled high, unless a jumper is placed across pins 2 and 3 of jumper block P12. In this way, placing the jumper simulates pressing a soft reset button.

The naresetapp example application demonstrates a simple mechanism for monitoring a GPIO pin and then initiating a soft reset when the pin achieves a particular value.

## Flash

---

### General Information

The Digi Connect ME has 2 MB of flash memory. The Digi Connect Wi-ME has 4 MB of flash memory. In both modules the flash memory is controlled by chip select 0, located at 0x02000000.

### Memory

The embedded modules have 8 MB of SDRAM memory, controlled by chip select 1, located at 0x00000000 in the processor address space and aliased at 0x04000000 and 0x08000000. The application program is loaded at address 0x08080000.

# Module Specifications

## A P P E N D I X A

### Network Interface

#### Digi Connect ME

- Standard: IEEE 802.3
- Physical Layer: 10/100Base-T
- Data Rate: 10/100Mbps (auto-sensing)
- Mode: Half-duplex and full-duplex support (auto-sensing)
- Connector: RJ-45

#### Digi Connect Wi-ME

- Standard: IEEE 802.11b
- Frequency: 2.4 GHz
- Data Rate: Up to 11 Mbps with automatic fallback
- Modulation: CCK (11/5 Mbps), DQPSK (2 Mbps), DBPSK (1 Mbps)
- Transmit Power: 16 dBm typical
- Receive sensitivity:
  - 1Mbps: -92 dBm
  - 2Mbps: -89 dBm
  - 5.5Mbps: -87 dBm
  - 11Mbps: -82 dBm
- Antenna Connector: 1 x RP-SMA

#### CAUTION!

The Digi Connect ME and Digi Connect Wi-ME embedded modules were designed for use in no clean flux wave soldering processes. The product is not designed to support draining after a water-wash process, which can lead to water residue inside the enclosure due to direct entry or condensation after the wash process.

## Serial Interface

---

One TTL serial interface (CMOS 3.3v) with full modem control signals (DTR, DSR, DCD, RTS, CTS).

## Data Rates (bps)

---

50, 110, 134, 150, 200, 300, 600, 1200, 2400, 3600, 4800, 9600, 19200, 38400, 57600, 115200, 230400

## Flow Control Options

---

RTS/CTS, XON/XOFF, None

## GPIO

---

Five GPIO (General Purpose Input/Output) ports are selectable between modem control and GPIO as follows:

- RTS/GPIO 4
- DTR/GPIO 5
- CTS/GPIO 2
- DCD/GPIO 1
- DSR/GPIO 3

## DC Characteristics

The following tables provide DC characteristics for operating conditions, inputs, and outputs.

Operating Conditions						
Symbol	Description	Min	Typ	Max	Unit	
V <sub>CC</sub>	Supply Voltage	3.14	3.3	3.45	V	
n/a	Power Supply Ripple			40	mVpp	
I <sub>CC</sub>	Supply Current	—	—	Digi Connect ME	270	mA
				Digi Connect Wi-ME	400	
I <sub>IL</sub>	Input Current as “0” (57K pull-up resistor)	—	—	57	μA	
I <sub>IH</sub>	Input Current “1” (57K pull-up resistor)	-10	—	10	μA	
I <sub>OZ</sub>	HighZ Leakage Current	-10	—	10	μA	
I <sub>OD</sub>	Output Drive Strength	—	—	2	mA	
C <sub>IO</sub>	Pin Capacitance (V <sub>O</sub> =0)	—	—	4	pF	

**Warning** The rise time of the 3.3v power supply must be between 700 μS and 140ms and the inrush current must be limited to less than 2 A. A rise time outside of these limits may cause the device to malfunction and give a 3-1-3 diagnostic error.

Inputs					
Symbol	Description	Min	Typ	Max	Unit
V <sub>IH</sub>	Input High Voltage	2	—	V <sub>CC</sub> +0.3	V
V <sub>IL</sub>	Input Low Voltage	V <sub>SS</sub> -0.3	—	0.2*V <sub>CC</sub>	V

Outputs					
Symbol	Description	Min	Typ	Max	Unit
V <sub>OH</sub>	Output High Voltage	2.4	—	3.45	V
V <sub>OL</sub>	Output Low Voltage	0	—	0.4	V

**Note** The embedded modules provide an on board supervisor circuit with a 2.88V reset threshold and an internal 5k pull-up resistor. When V<sub>CC</sub> falls to the threshold voltage, a reset pulse is issued, holding the output in active state. When power rises above 2.88V, the reset remains for approximately 250 ms to allow the system clock and other circuits to stabilize.

## Environmental

	Digi Connect ME	Digi Connect Wi-ME
Ambient Temperature	-40°F to 185°F (-40°C to 85°C)	-4°F to 185°F (-30°C to 75°C)
Storage Temperature	-40°F to 257°F (-40°C to 125°C)	
Humidity	5% to 90%	
Altitude	12000 feet (3657.60 meters)	

## Mechanical

Dimensions	Digi Connect ME	Digi Connect Wi-ME	
Length	1.445 in. (36.703 mm)	2.117 in (53.78 mm)	
Width	0.75 in. (19.05 mm)		
Height	0.854 in. (21.69 mm)		
Weight	.616oz. 17.463g	.696 oz. 19.731 g.	Antenna- .408 oz. 11.567 g
		Total - 1.104 oz. 31.298 g	
Device/serial interface connector	20-pin micro header (10-pin double row) with .05-inch (1.27-mm) pitch (Samtec P/N FTS-110-01-F-DV-TR or similar). Positions 3 through 6 are removed.		

## Bar Code

The 50m PN is code 3 of 9 (39) and the MAC is code 128. All scanners are set up so if they read code 3 of 9 they will automatically read 128. The reason for the two different code types is to maximize the size of the bars within a given space to improved readability.

## Dimensions

The following figures show the dimensions of Digi Connect Wi-ME and Digi Connect ME embedded modules.

**Note:** These are the tolerances for the drawings shown on this and the following pages:

Measure	Tolerance
.XX	± .02
.XXX	± .010
Angles	± 2 degrees

### Digi Connect Wi-ME Module

#### Front Wi-ME

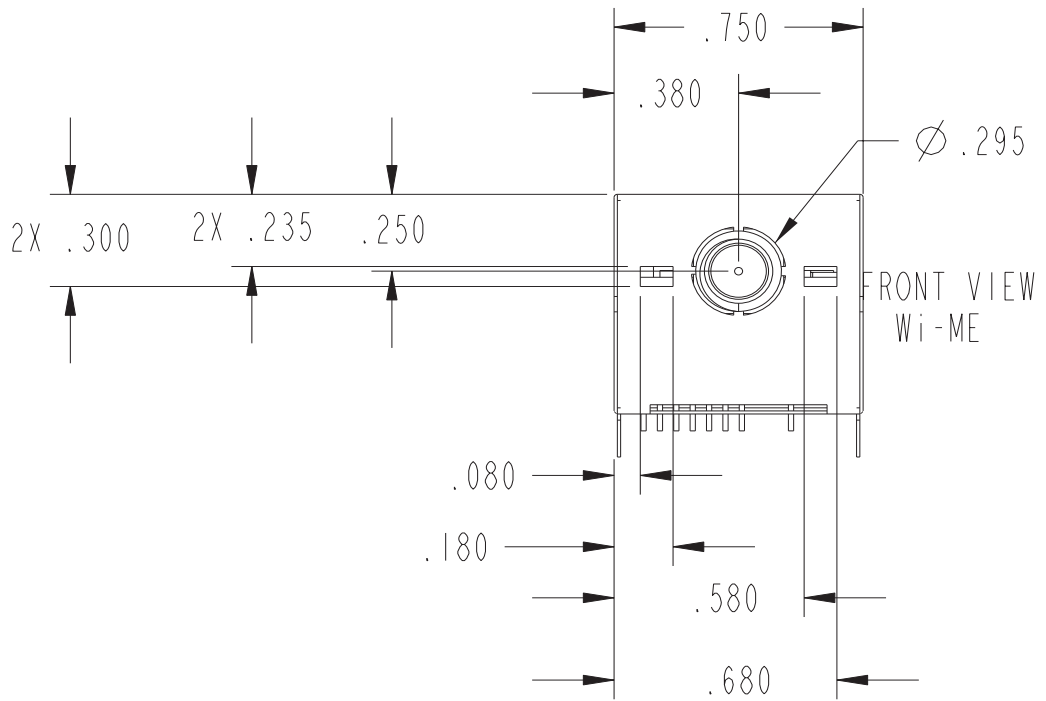



**Side Wi-ME**

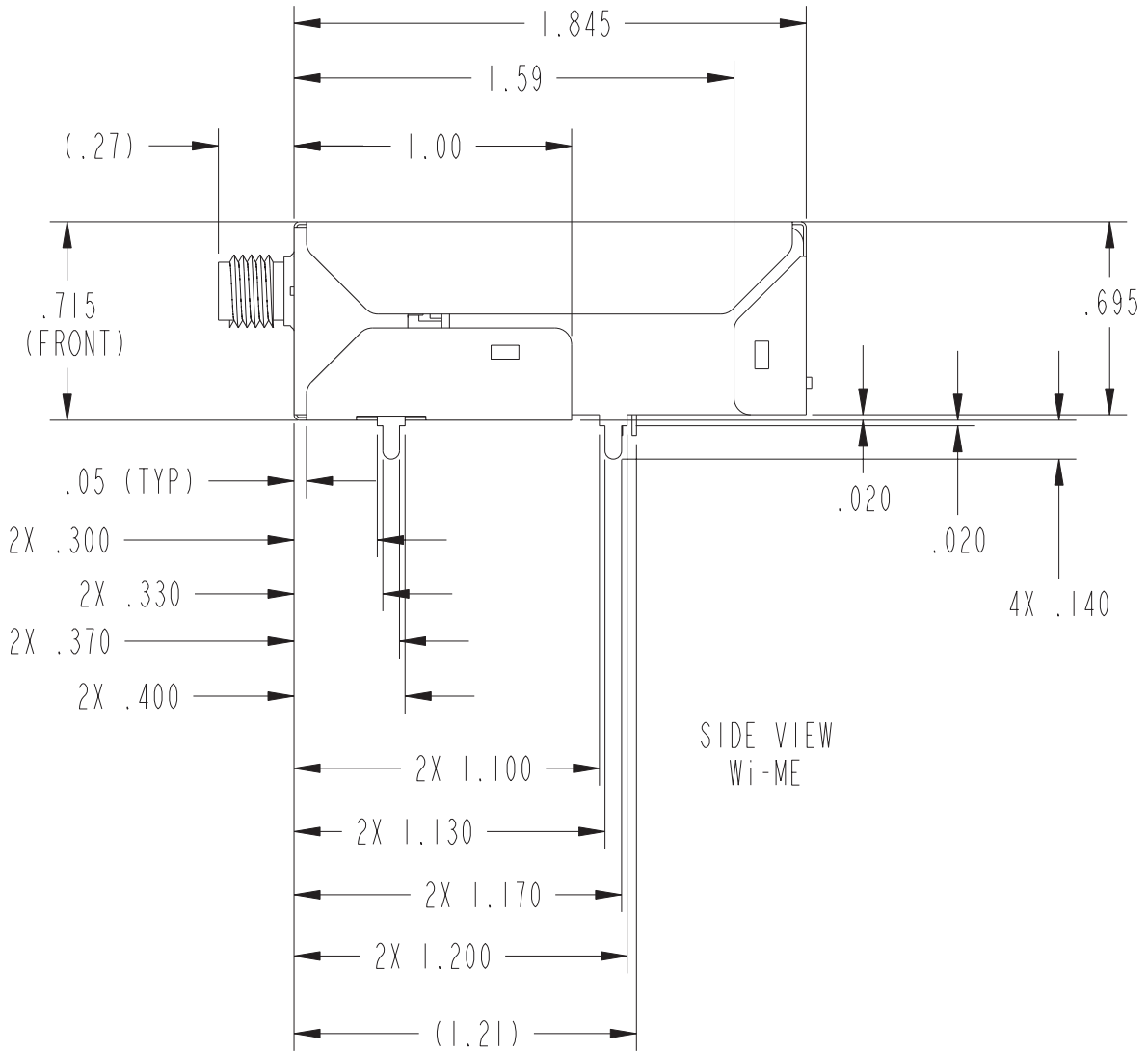

### Bottom Wi-ME

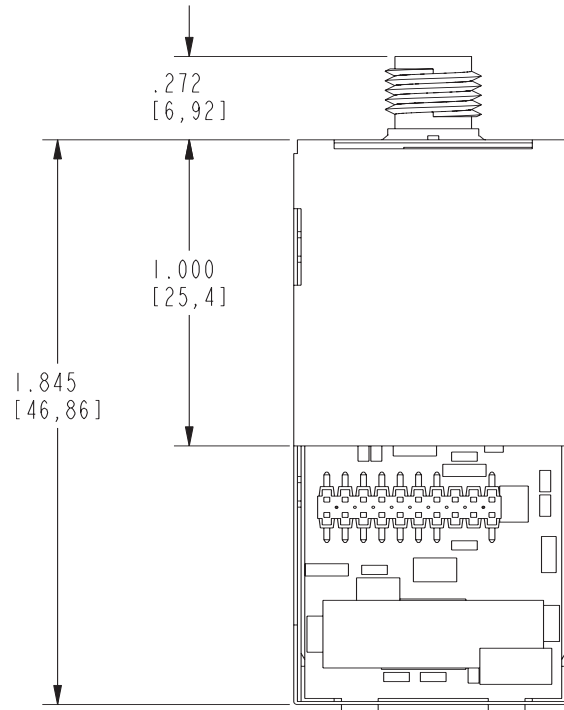

## Digi Connect ME Module

### Front View

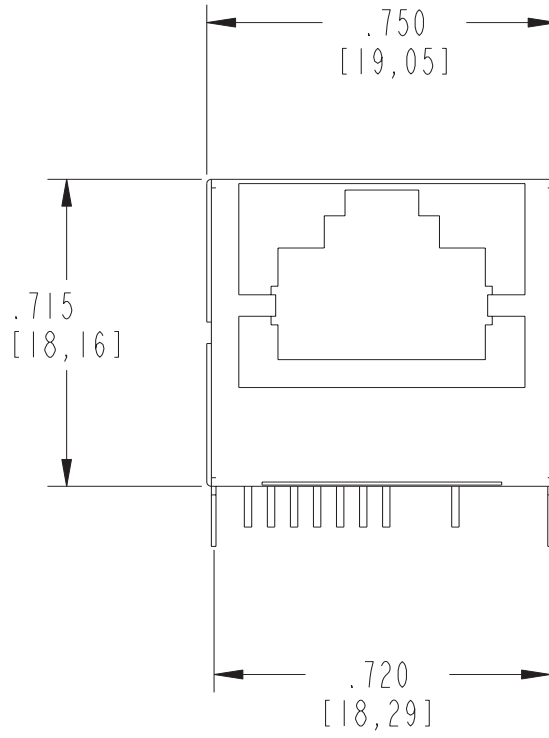

Side

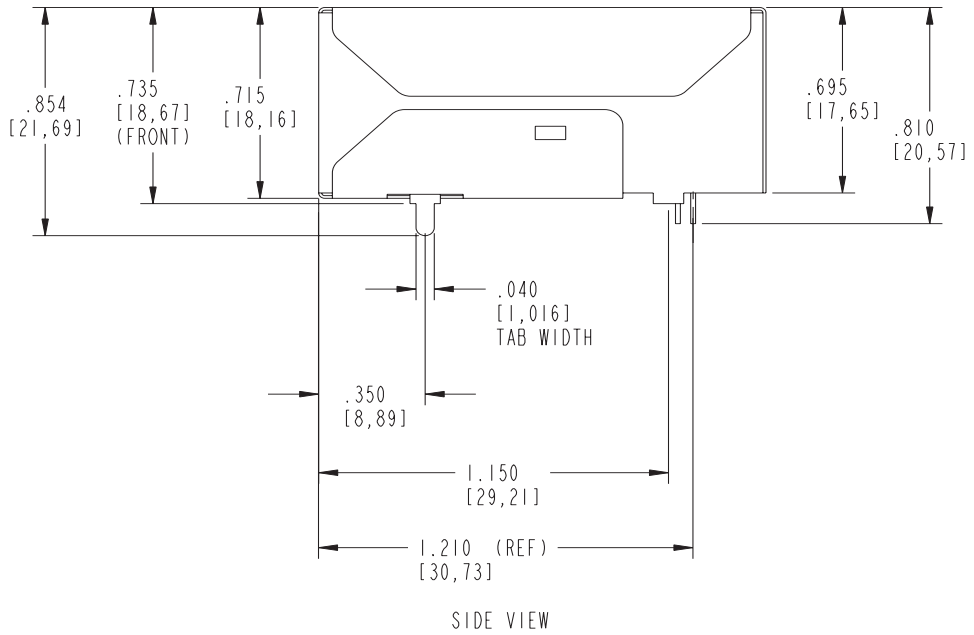

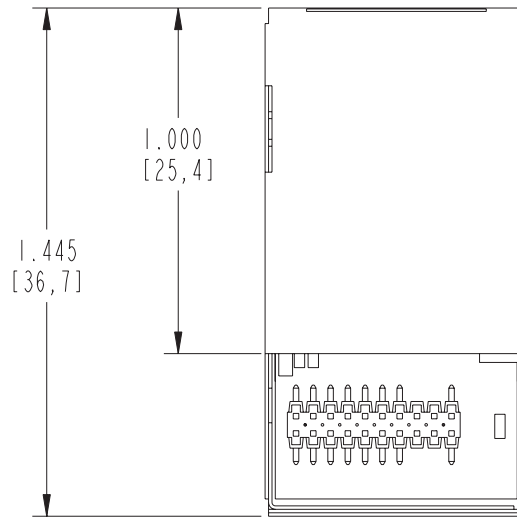
**Bottom****Recommended PCB Layout**  
.....

The following figure shows the recommended PCB (printed circuit board) layout of the Digi Connect Wi-ME and Digi Connect ME. It is strongly recommended that you consider using the Digi Connect Wi-ME footprint for future flexibility.

### Digi Connect ME and Wi-ME

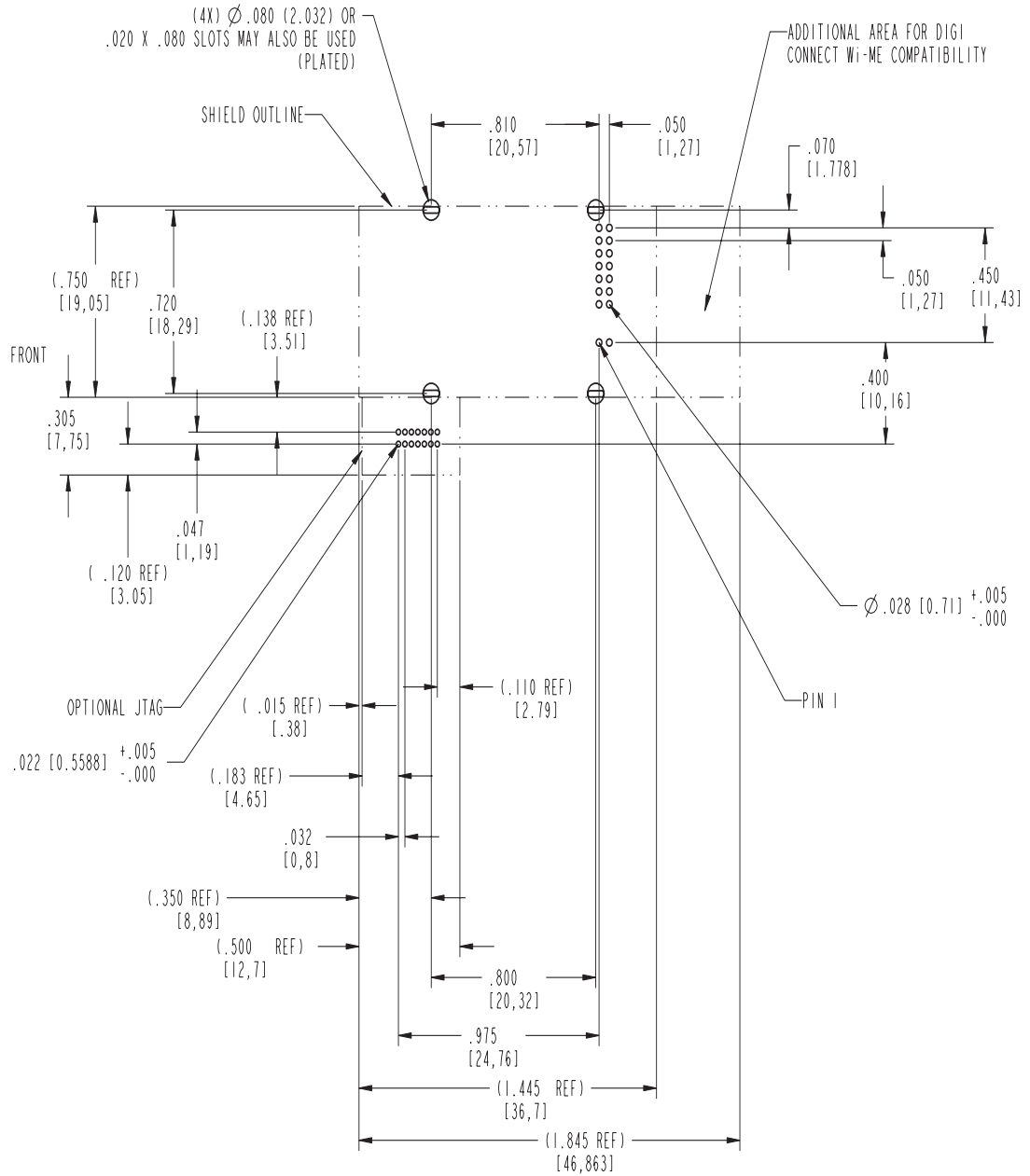

## Antenna Information

---

### Antenna Strength

The following diagram demonstrates the strength of the signal received by the whip antenna on both a horizontal and vertical plane. The diagram shows the magnetic field when the antenna is in a vertical position. The outside line represents the horizontal plane and the inside dotted line represents the vertical plane.

### Radiation Patterns

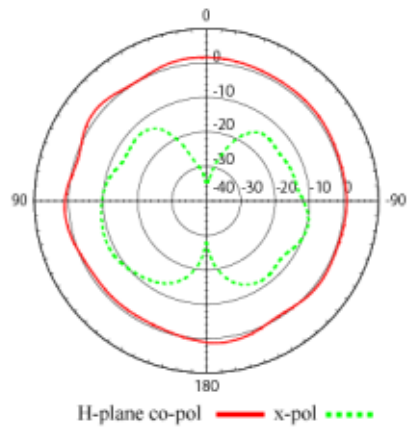

## Antenna Specifications

Antenna Description	Dipole	Desktop
<b>Frequency</b>	2.4~2.5 GHz	2.4~2.5 GHz
<b>Power Output</b>	2 W	1 W
<b>DB Gain</b>	2 dBi	1.8 dBi
<b>VSWR</b>	< or = 2.0	1.92 max.
<b>Dimension</b>	108.5 x 10.0 mm	105 x 4.5 mm
<b>Weight</b>	10.5g	11 g
<b>Connector</b>	RP-SMA	
<b>Part Number</b>	DC-ANT-24DP	DC-ANT-24DT

Any antenna matching the in-band and out-of-band signal patterns and strengths of the antenna, whose characteristics are given in the Antenna Description table and the Radiation pattern graphic may be used with the Digi Connect Wi-ME.



*Desktop Antenna Dimensions*

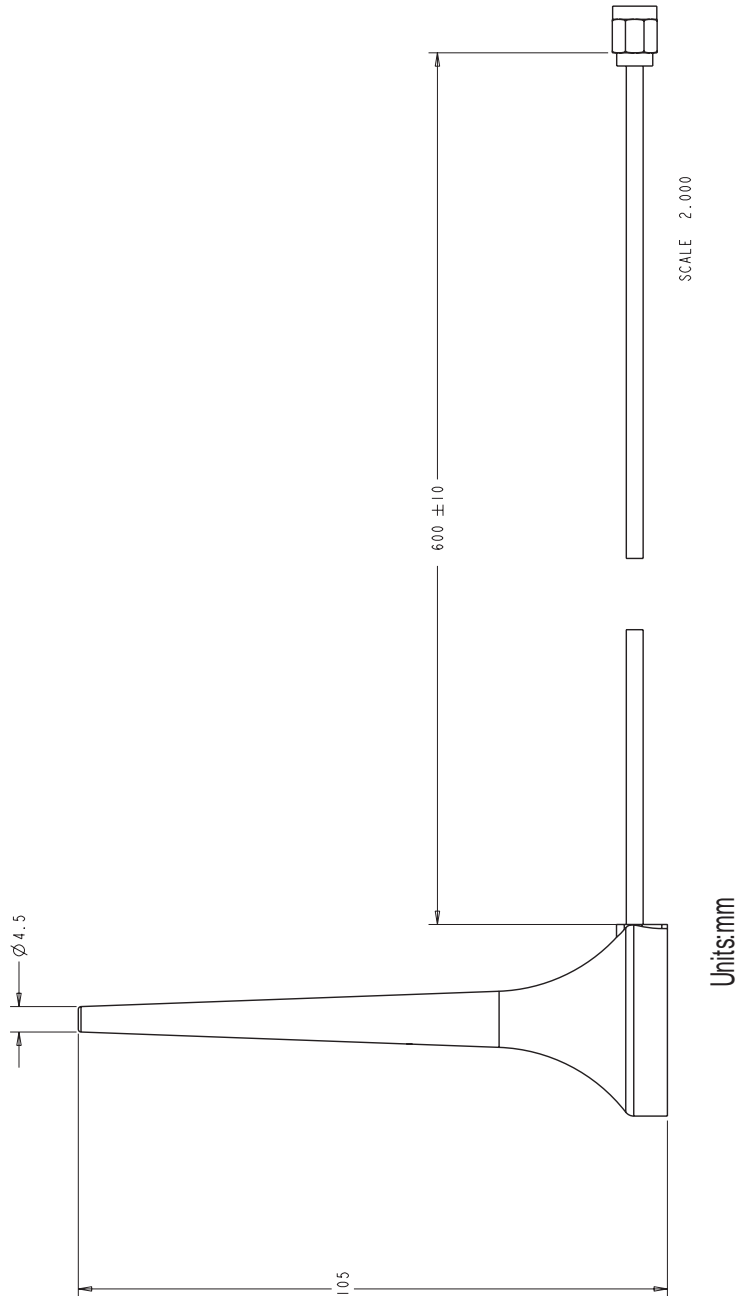

### Dipole Antenna Dimensions

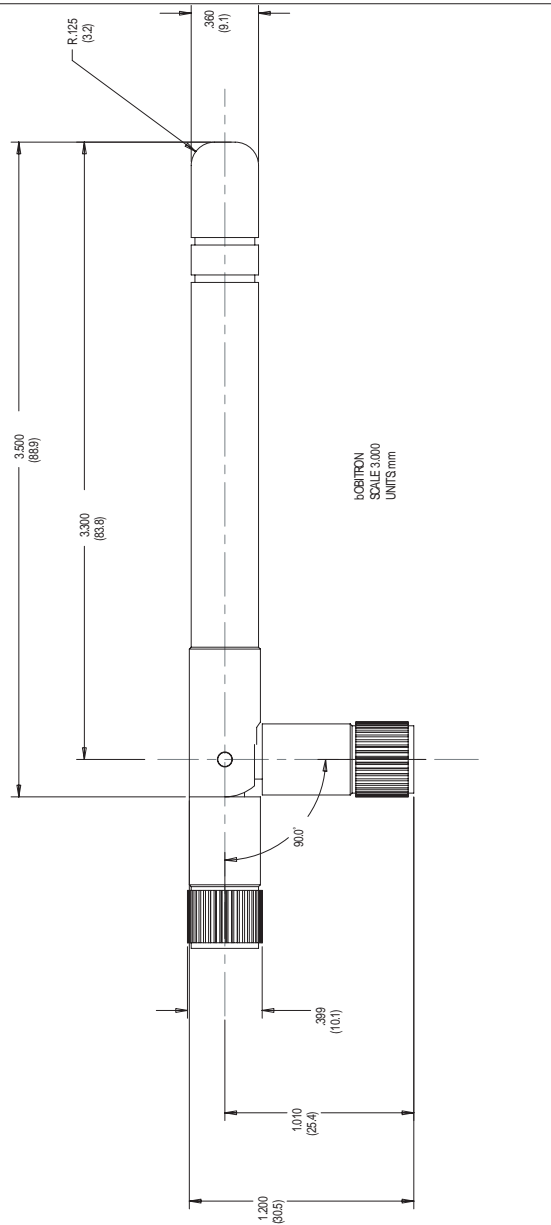

## RF Exposure Statement

---

The Digi Connect Wi-ME module complies with the RF exposure limits for humans as called out in RSS-102. It is exempt from RF evaluation based on its operating frequency of 2.4 GHz, and effective radiated power less than the 3 watt requirement for a mobile device (>20 cm separation) operating at 2.4 GHz.

## Safety Statements

---

### To avoid contact with electrical current:

- Never install electrical wiring during an electrical storm.
- Never install an ethernet connection in wet locations unless that connector is specifically designed for wet locations.
- Use caution when installing or modifying ethernet lines.
- Use a screwdriver and other tools with insulated handles.
- You and those around you should wear safety glasses or goggles.
- Do not place ethernet wiring or connections in any conduit, outlet or junction box containing electrical wiring.
- Installation of inside wire may bring you close to electrical wire, conduit, terminals and other electrical facilities. Extreme caution must be used to avoid electrical shock from such facilities. You must avoid contact with all such facilities.
- Ethernet wiring must be at least 6 feet from bare power wiring or lightning rods and associated wires, and at least 6 inches from other wire (antenna wires, doorbell wires, wires from transformers to neon signs), steam or hot water pipes, and heating ducts.
- Do not place an ethernet connection where it would allow a person to use an ethernet device while in a bathtub, shower, swimming pool, or similar hazardous location.
- Protectors and grounding wire placed by the service provider must not be connected to, removed, or modified by the customer.

- Do not touch uninsulated ethernet wiring if lightning is likely!
  - Do not touch or move the antenna(s) while the unit is transmitting or receiving.
  - Do not hold any component containing a radio such that the antenna is very close to or touching any exposed parts of the body, especially the face or eyes, while transmitting.
  - Do not operate a portable transmitter near unshielded blasting caps or in an explosive environment unless it is a type especially qualified for such use
- Any *external* communications wiring you may install needs to be constructed to all relevant electrical codes. In the United States this is the National Electrical Code Article 800. Contact a licensed electrician for details.

# *Certifications*

---

## A P P E N D I X B

These products comply with the following standards.

### **FCC Part 15 Class B**

---

#### **Radio Frequency Interference (RFI)(FCC 15.105)**

The Digi Connect ME and Digi Connect Wi-ME embedded modules have been tested and found to comply with the limits for Class B digital devices pursuant to Part 15 Subpart B, of the FCC Rules. These limits are designed to provide reasonable protection against harmful interference in a residential environment. This equipment generates, uses, and can radiate radio frequency energy, and if not installed and used in accordance with the instruction manual, may cause harmful interference to radio communications. However, there is no guarantee that interference will not occur in a particular installation. If this equipment does cause harmful interference to radio or television reception, which can be determined by turning the equipment off and on, the user is encouraged to try and correct the interference by one or more of the following measures:

- Reorient or relocate the receiving antenna.
- Increase the separation between the equipment and the receiver.
- Connect the equipment into an outlet on a circuit different from that to which the receiver is connected.
- Consult the dealer or an experienced radio/TV technician for help.

## **Labeling Requirements (FCC 15.19)**

This device complies with Part 15 of FCC rules. Operation is subject to the following two conditions: (1) this device may not cause harmful interference, and (2) this device must accept any interference received, including interference that may cause undesired operation.

If the FCC ID is not visible when installed inside another device, then the outside of the device into which the module is installed must also display a label referring to the enclosed module FCC ID. This exterior label can use wording such as the following: "Contains Transmitter Module FCC ID: MCQ-50M880/ IC: 1846A-50M880".

## **Modifications (FCC 15.21)**

Changes or modifications to this equipment not expressly approved by Digi may void the user's authority to operate this equipment.

## **Industry Canada**

---

This digital apparatus does not exceed the Class B limits for radio noise emissions from digital apparatus set out in the Radio Interference Regulations of the Canadian Department of Communications.

Le present appareil numerique n'emet pas de bruits radioelectriques dépassant les limites applicables aux appareils numeriques de la class B prescrites dans le Reglement sur le brouillage radioelectrique edicte par le ministere des Communications du Canada."

## Declaration of Conformity

---

(In accordance with FCC Dockets 96-208 and 95-19)

**Manufacturer's Name:** Digi International

**Corporate Headquarters:** 11001 Bren Road East  
Minnetonka MN 55343

**Manufacturing Headquarters:** 10000 West 76th Street  
Eden Prairie MN 55344

Digi International declares, that the product:

**Product Name:** Digi Connect ME embedded module  
**Model Number:** 50000866-XX and 50000878-XX

**Product Name:** Digi Connect Wi-ME embedded module  
**Model Number:** 50000880-XX

to which this declaration relates, meets the requirements specified by the Federal Communications Commission as detailed in the following specifications:

- Part 15, Subpart B, for Class B Equipment
- FCC Docket 96-208 as it applies to Class B personal
- Computers and Peripherals

The product listed above has been tested at an External Test Laboratory certified per FCC rules and has been found to meet the FCC, Part 15, Class B, Emission Limits. Documentation is on file and available from the Digi International Homologation Department.

## International EMC Standards

The Digi Connect ME and Digi Connect Wi-ME embedded modules meet the following standards:

Standards	Digi Connect ME	Digi Connect Wi-ME
<b>Emmissions</b>	AS/NZS 3548	AS/NZS 3548 CISPR 22
		Japan IOH 003NY04115 0000 003GZ04064 0000
		FCC Part 15 Subpart C (FCC ID: MCQ-50M880)
		IC RSS 210 (IC:1846A-50M880)
	FCC Part 15 Subpart B ICES-003 EN 55022 EN 61000-4-2 EN 61000-4-3 EN 61000-4-6 EN 301 489-3 EN 300 328 VCCI	
<b>Immunity</b>	EN 55024	
<b>Safety</b>	UL 60950-1 CSA 22.2 No. 60950--1 EN 60950	



# *Sample Application: TTL Signals to EIA-232*

---

## A P P E N D I X C

The following schematic is an example of how to convert the modules's TTL signals to EIA-232.

# SAMPLE APPLICATION

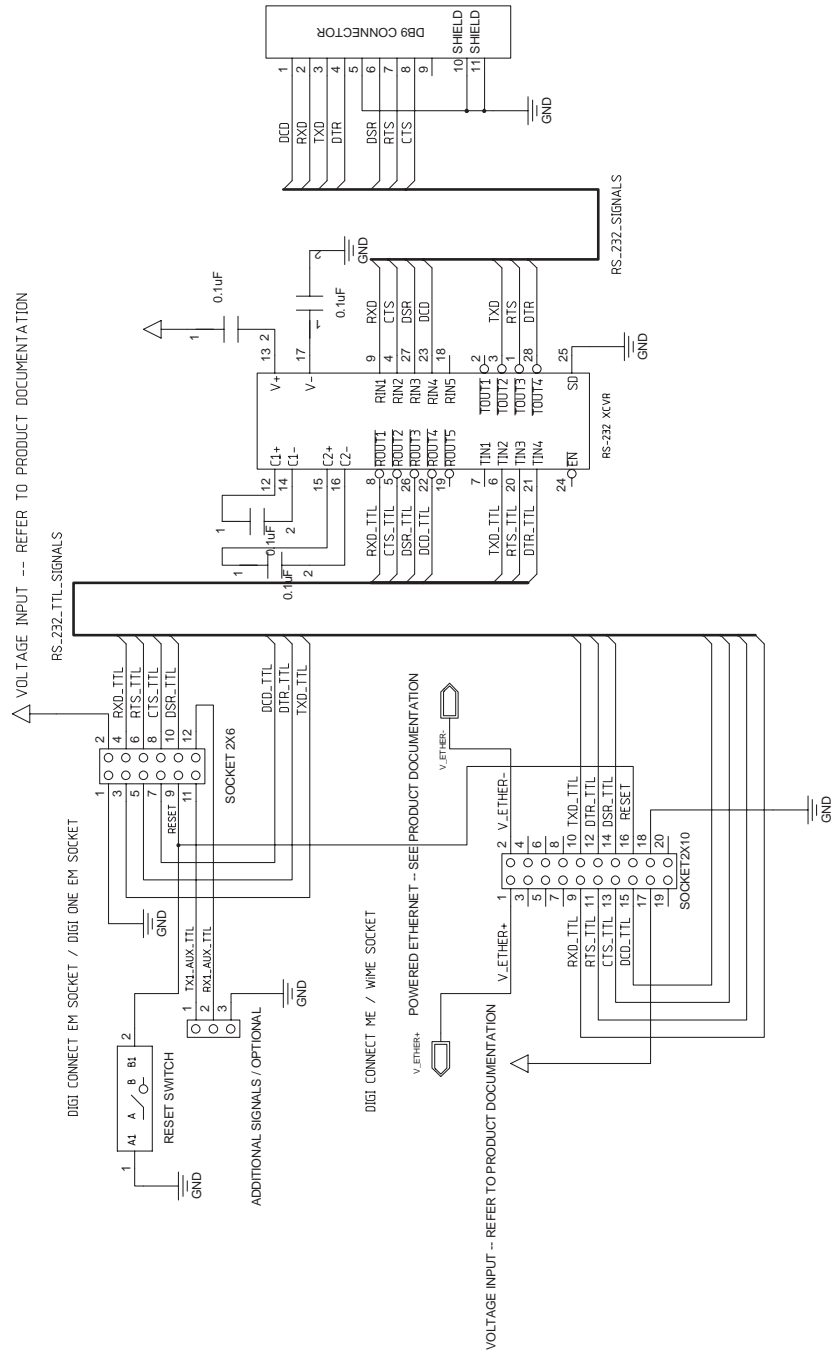

# *Change Log*

## A P P E N D I X D

The following changes have been made since the last revision of this document.

### **Revision G**

Updated the Connectors: power and device interface section to say that pins 1 and 2 on the connector are available if using Connect ME, not available if using Connect Wi-ME.

Updated the Embedded Module Connector table in Chapter 2 similarly.

Added tolerance information for dimension drawings

Updated Hard Reset section to clarify forcing the unit into hard reset

Updated the ambient (operating) temperature for Connect Wi-ME

Added information regarding reading the bar code

Added P12 Factory reset pin

### **Revision F**

Updated Antenna drawing

Added product weights

Updated UL labeling description

Updated dimension drawings

## Revision E

---

- Added Japan certification
- Improve dipole antenna drawing
- Corrected imperial pitch measurement
- Reformatted tables for easier reading
- Added antenna extension cord information
- Added more receive sensitivity information
- Added Caution for soldering process
- Added reset hold times
- Added VCC \*absolute max\* ratings
- Combined PCB layouts with improvements



